

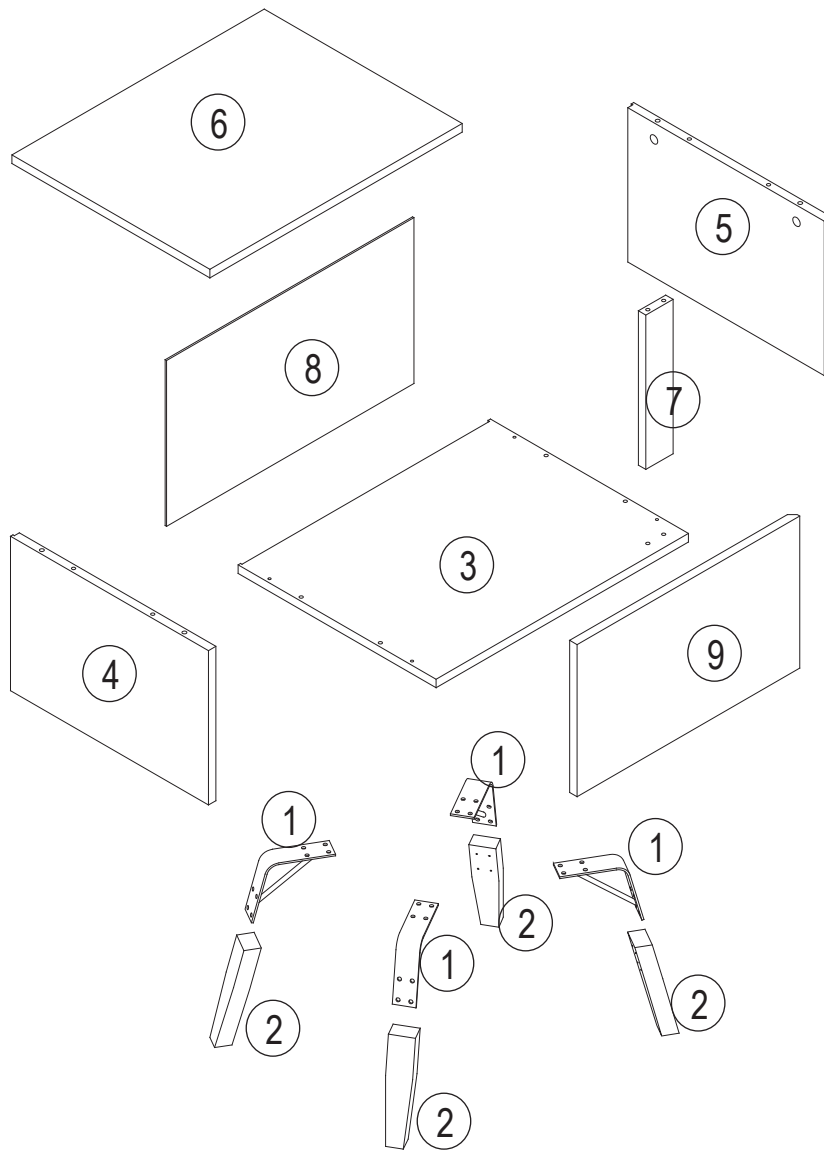







NÖA & NANI
FAMILY FURNITURE



**OTTO Bedside Table
ASSEMBLY INSTRUCTIONS**

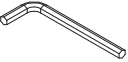

Hardware:

Part No.	Part	Quantity	Part No.	Part	Quantity
A		32pcs	F		4pcs
B		12pcs	G		10pcs
C		4pcs	H		2pcs
D		1pc	I		12pcs
E		4pcs			

Tools Required

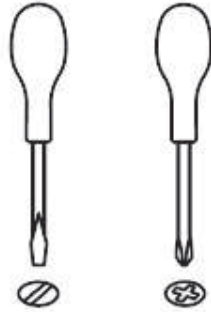

CAUTION: Do not use tools other than those required, as this can damage your new item.

NOTE

- Please check you have all hardware before assembling.
- If you are missing any hardware, please contact the store of purchase.
- Please ensure you have the name of the item, required hardware part and quantity.
- Please retain your receipt as proof of purchase to validate your warranty.

CAUTION

- Do not tighten screws before all screws are in the right place.
- Do not use this product unless all bolts, screws and knobs are firmly secured.
- Check that all bolts, screws and knobs are securely tightened at least every 4 months.

WARNING

- If parts are missing, broken, damaged or worn stop using the product until all repairs are made using manufacturer authorised parts.
- Failure to follow these warnings could result in serious injury.

DANGER

- CHILDREN MUST BE SUPERVISED.

Step1

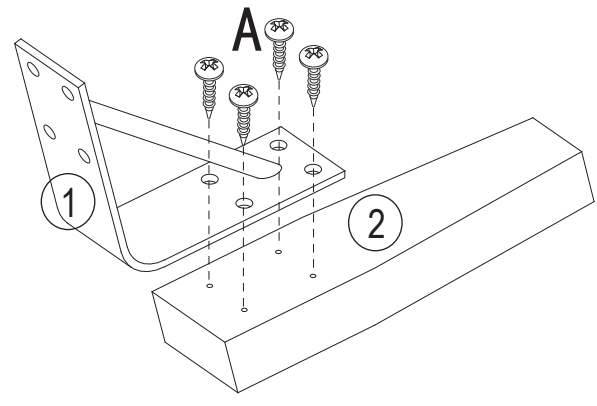

X 4

A  16pcs

Step2

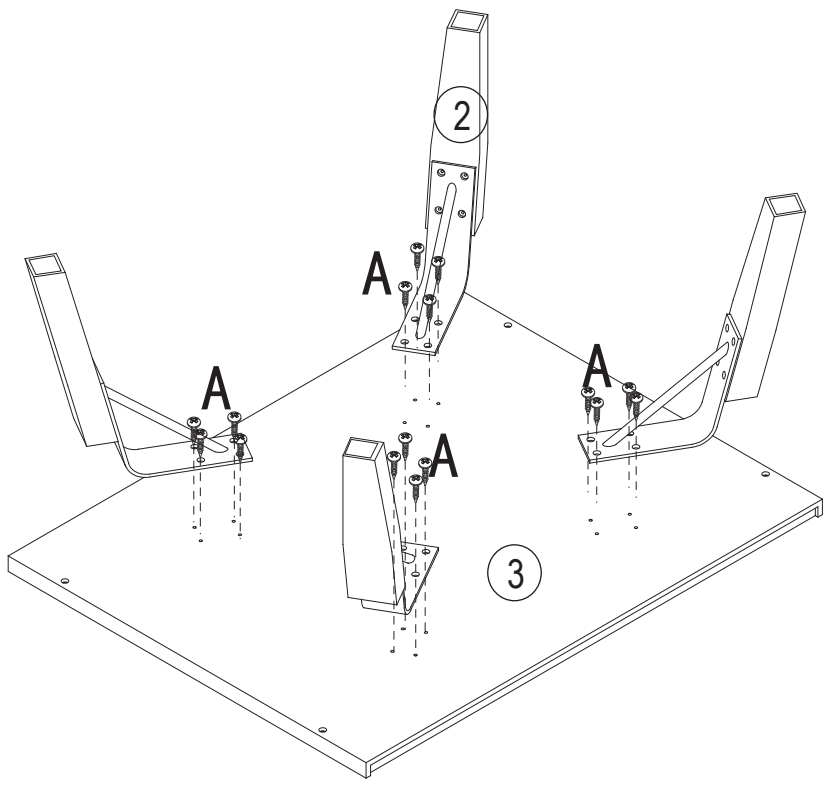

A  16pcs

Step3

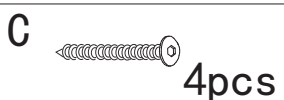
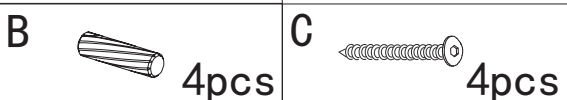
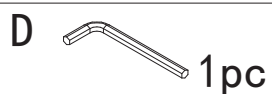
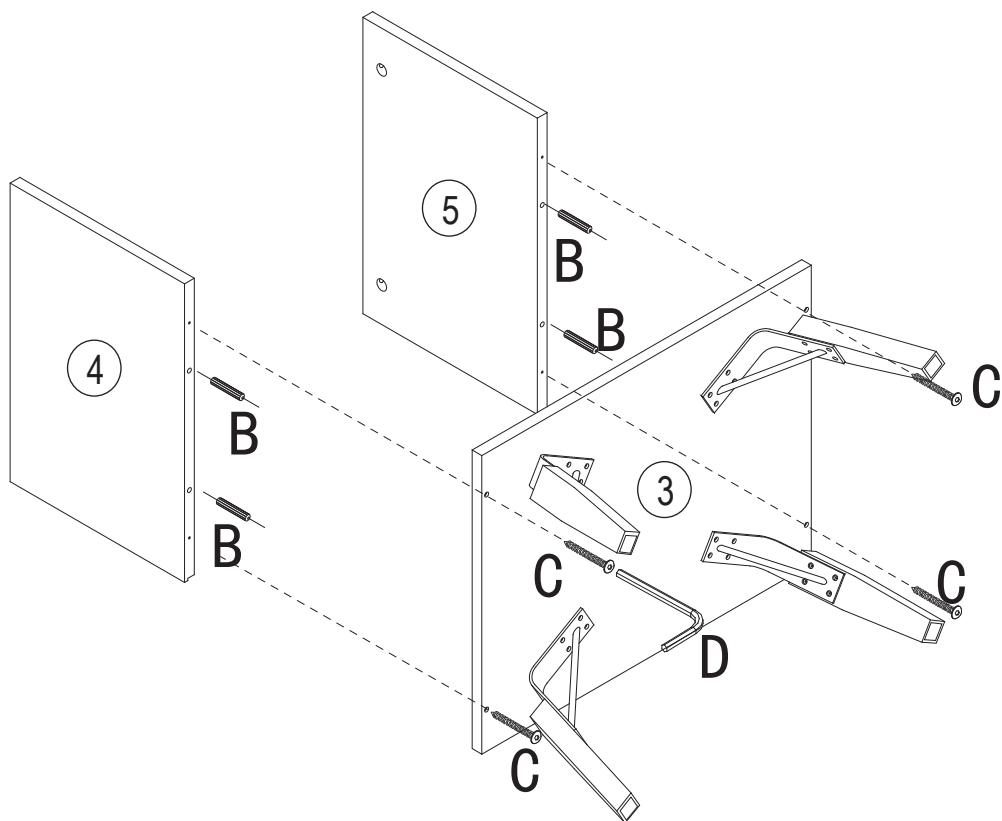

Step4

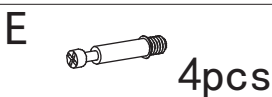
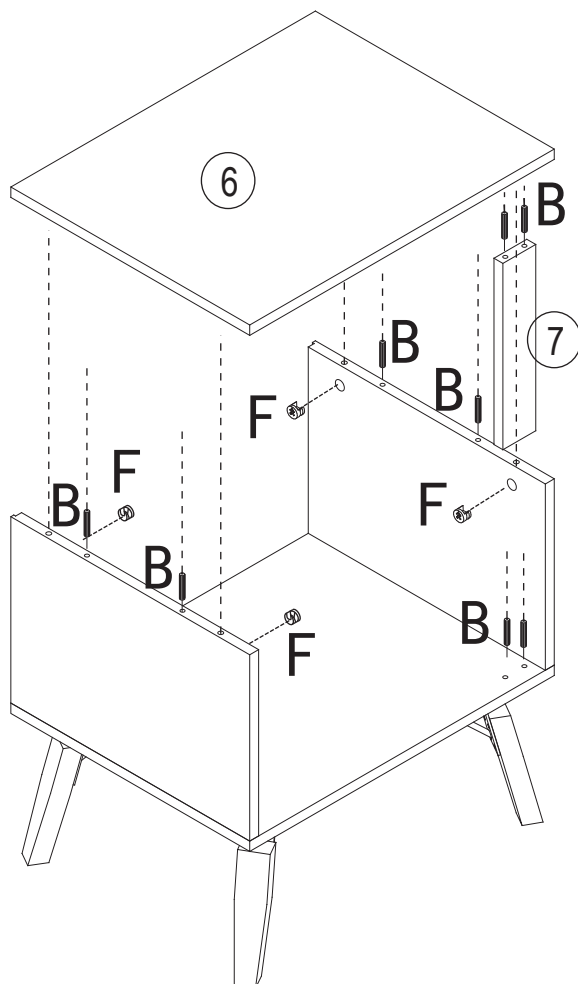
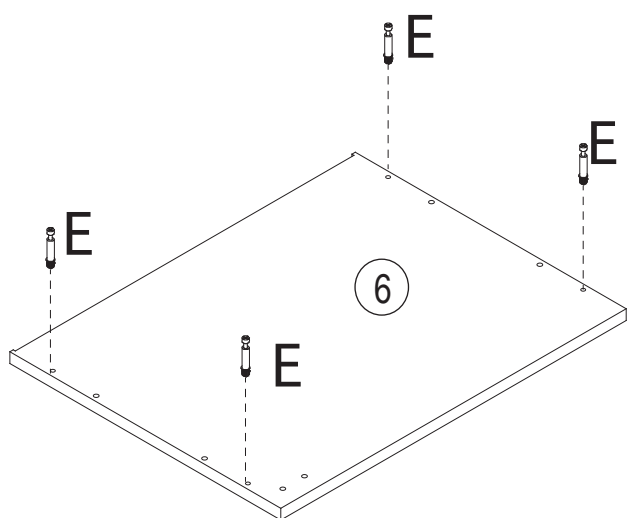

Step5

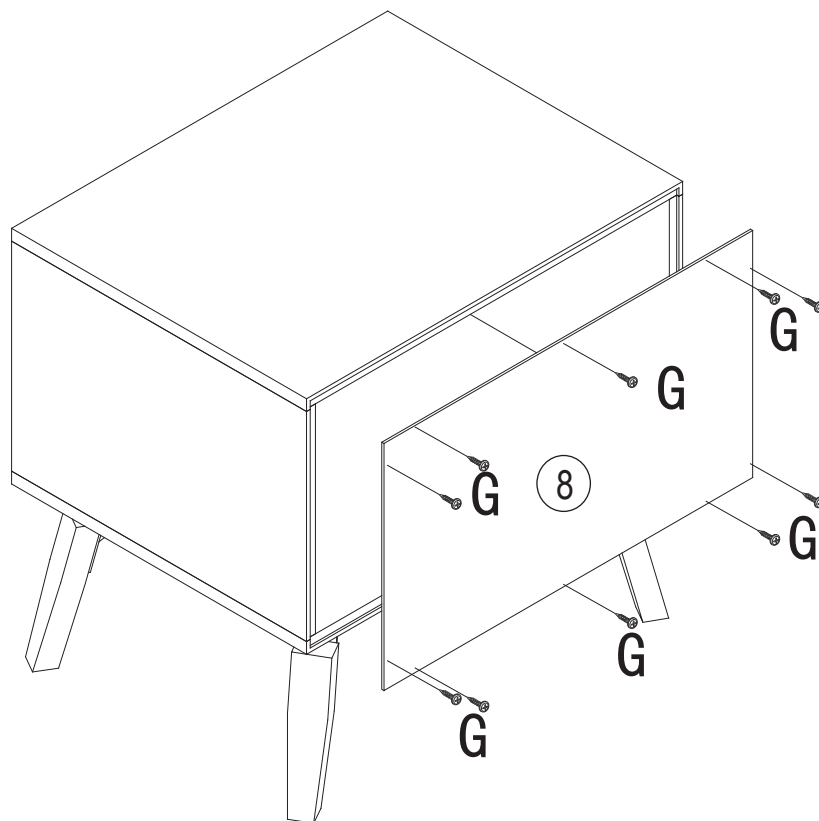

G



10pcs

Step6

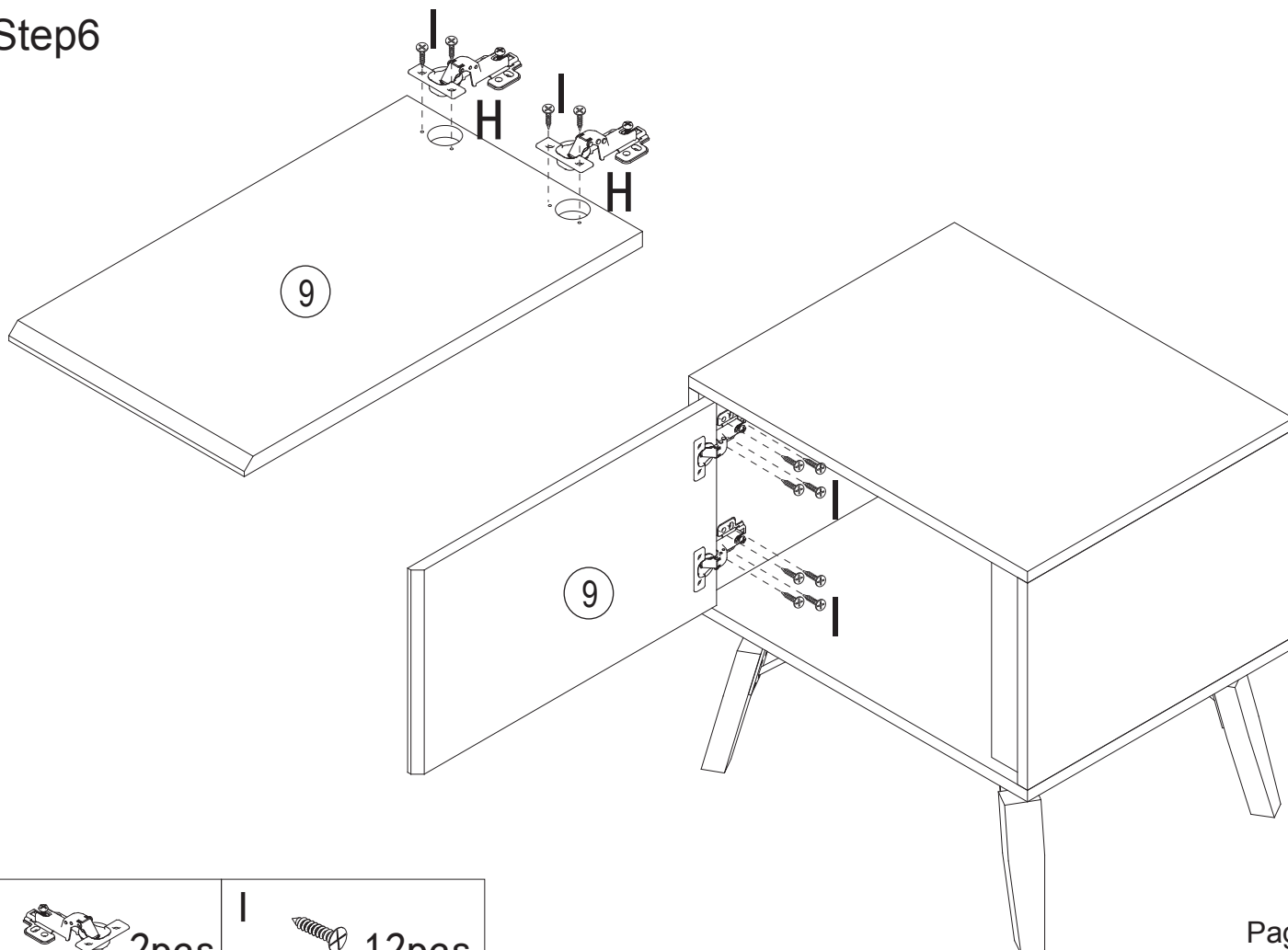

H



2pcs

I



12pcs

Safety Information

Please ensure the item is fully tightened and secured. We would also recommend checking the bolts of the item over time to ensure that the item is still secured correctly, this will guarantee you will be able to enjoy the product for many years to come.

Return Information

If you have any problems with the item just email us at info@noaandnani.co.uk or give us a call and we can resolve it for you, our technical team will be able to assist in helping. If you have any parts that are damaged we can replace them for you. If you do need to return the item for some reason just email us to request an RMA number and fill in the form on the next page and we can arrange the return of the goods.

Assembly Information

We understand that self assembly furniture can be a pain but we try and make it as easy as possible for anyone to build, if you have found a problem with the assembly of the product or with the assembly instructions or you have comments on how we would improve them, we would love to hear from you. Just contact us either by email at productadvice@noaandnani.co.uk or by phone.

Related items

We have a matching range of items that compliment this product, just head to noaandnani.co.uk for the full selection.

NÖA & NANI
FAMILY FURNITURE



www.NoaandNani.co.uk



Return Merchandise Authorization RMA

Buyers Name:

Address:

Postal Code:

Telephone:

RMA Number:

Signature:

Number of Packages to Return:

Collection Charge Amount:

RMA Agreement

All goods will be returned as per request, if there are multiple packages these will all be returned. The courier will collect the amount of packages as stated. Any failure to give all the packages to the courier will result in an additional collection fee and/or a deduction from the refund total.

Images of returned packages included. Please tick

(Why do we require images?) Due to the nature of our oversized items going through the courier networks it is important that prior to booking in the collection, we can see the size of the parcels being returned. This avoids couriers attempting a collection and refusing to collect the goods, which means you haven't wasted time waiting in for the collection not to take place.

Failed Collections

If a collection is booked in and the collection fails due to no-one being at the property to give the goods back, a fee of 50% off the collection charge will be charged. The collection will then need to be booked in again and an additional collection charge will be incurred.

IMPORTANT: Please ensure the RMA Number is clearly written on all of the packages . This will ensure the refund will be processed swiftly.